

RONGTA USER MANUAL

RP211 / RP212 Thermal Label Printer

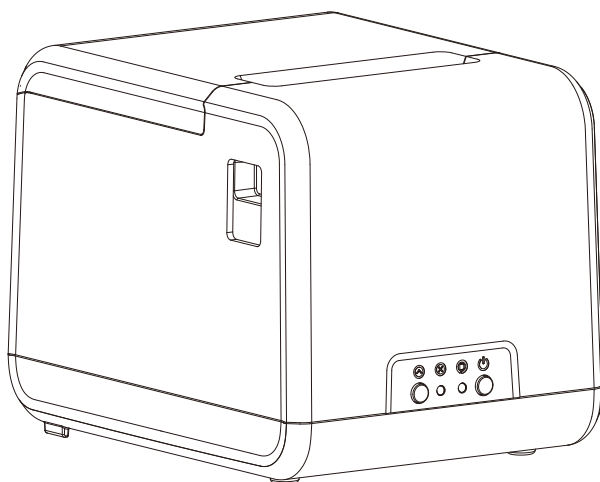





Contents

I. Product Introduction	2
1.1 Safety Warnings	2
1.2 Main Features	2
II. Safety Instructions	3
III. Appearance and Components	4
IV. Technical Parameters.....	5
4.1 Printing Parameters	5
4.2 Printer Indicators.....	6
4.3 Printer Interfaces	6
V. Installation and Operation of Printer	7
5.1 Printer Unpacking	7
5.2 Connecting the Printer	7
5.3 Loading Paper.....	8
VI. The Switch, Key and Indicator Light of Printer	9
6.1 Keys and Indicators	9
6.2 Self-Test of Printer	10
6.3 Special Functions of Printer	10
VII. USB Interface	12
VIII. Ethernet Interfaces of Printers	13
IX. Cashbox Interfaces of Printers.....	14
X. Cleaning the Printer.....	15
10.1 Cleaning the Printer Head	15
10.2 Cleaning the Sensor.....	15
10.3 Cleaning the Printing Rubber Roller	16
XI. Troubleshooting.....	17
11.1 The indicator on the control panel is not on	17
11.2 The indicator on the control panel is not on.....	17
XII. Driver Installation	18
12.1 Installation for Windows.....	18
12.2 The Port Direct Drive	18

I. Product Introduction

Thank you for purchasing the thermal label printer produced by our company. This thermal label printer provides you with safe, reliable and efficient printing quality at a reasonable economic price. At the same time, The printer is widely used in supermarkets, hospitals, restaurants, banks, gas stations, road and bridge toll collection and other fields due to its super functions and easy operation.

1.1 Safety Warnings

-  **Warning:** Do not touch the paper cutting knife or paper-tearing knife of the printer.
-  **Warning:** The print head is a heating component. Do not touch the print head and its surrounding components when the printer is still warm in temperature.
-  **Warning:** Do not touch the surface of the thermal print head and connectors, to avoid electrostatic damage to the print head.
-  **Warning:** This product is only suitable for the use in non-tropical climates.

1.2 Main Features

- High printing quality
- Low noise
- The attractive appearance
- Reasonable structure, simple use and maintenance
- Label off intelligent handling function
- Superior heat dissipation, can handle heavy printing workload
- Reprinting function, can effectively avoid the loss and omission of label information in the printing process caused by lack of paper.
- Automatic paper positioning after re-opening and re-closing the cover, Can effectively avoid the trouble and waste of labels caused by printing dislocation
- Automatic identification of paper

II. Safety Instructions

Before operating and using the printer, please carefully read the following items and strictly observe the use rules.

- ① Please install the printer on a stable surface to avoid printer suffered from any vibration and shocks.
- ② Stop using keeping the product in any case of unusual circumstances such as the presence of high temprature, high humidity and serious pollution.
- ③ Connect the printer's power adapter to an appropriate grounding socket. Avoid using the same socket with large motors or other equipment that may cause voltage fluctuation of power supply.
- ④ Do not get the product wet. Do not insert foreign objects(e.g. metal) into the product, and once it occurs, immediately turn off the power supply.
- ⑤ Never use the printer without paper, otherwise it will seriously damage the printing rubber roller and thermal head.
- ⑥ Unplug the product from the power outlet if the printer is idle for a long time.
- ⑦ Do not disassemble or modify the product personally.
- ⑧ Use only the power adapter specified in this instruction.
- ⑨ In order to ensure the printing quality and prolong the service life of the product, it is recommended to use the recommended or equivalent thermal printing paper.
- ⑩ Do not plug/unplug the product with the product powered on.
- ⑪ When plugging and unplugging the printer power cord, please hold the arrow position of the printer power connector with your hand, not the cord of the printer power cord.
- ⑫ Please keep this manual for the future use and reference.

III. Appearance and Components

Front View

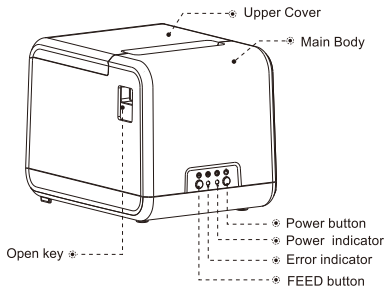

Rear View

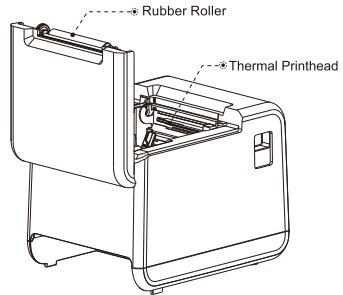

Inside View

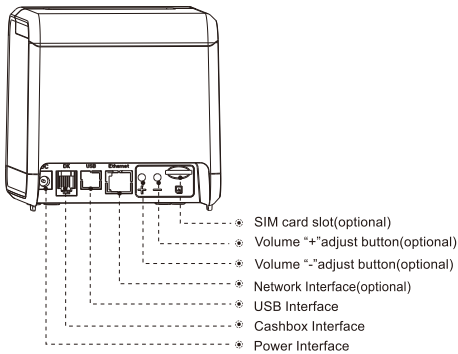

Application Field

- Cashier system of places of entertainment
- Catering cashier system
- Cashier system of retail monopoly
- Postal logistics receipt printing system
- Wireless Bluetooth printing cashier system
- Hotel receipt printing system

IV. Technical Parameters

4.1 Printing Parameters

Model	RP211/RP212
Printing method	Thermal line printer
Printing speed	RP211: 100mm/s \ RP212: 127mm/s
Printing paper width	20~60(±0.5mm)
Effective resolution	203 dpi (8 dot/mm)
Thickness of printing paper	0.06-0.14mm
Effective printing width	RP211:Max 48mm \ RP212: Max 56mm
Dot density	384dot/line or 448dot/line
Character size	ASCII Font A: 12x24 ASCII Font B: 9x17 Chinese character 24x24
Print character	
ASCII character set	12x24 dot, 1.25 (width)X3.00 (height)mm
National Standard Class I and II Chinese Character Font	24x24 dot, 3.00 (width)X3.00 (height)mm
Type of bar code	One-dimensional code:Code 39, 39C, I25, Code 93, ITF25, EAN128, Code 128, Codabar, EAN-8, EAN8+2, EAN8+5, EAN-13, EAN13+2, EAN13+5, UPC-A, UPCA+2, UPCA+5, UPC-E, UPCE+2, UPCE+5 MSIC, ITF14, EAN14, CODE11, POST QR code:PDF417(optional)
Extended character table	CP437, CP850, CP852, CP860, CP863, CP865, CP866, WPC1250, WPC1251, WPC1252, WPC1253, WPC1254
Power supply	
Power adapter	AC 100 ~ 240V
Input power supply	RP211: DC 8.5V \equiv 3A RP212mm: DC 12V \equiv 2A
Cashbox output	DC 12V \equiv 1A
Service life	
Service life	The service life of thermal printhead 50 kilometers
Environmental requirements	
Working environment	Operating temperature: 0~45°C, operating humidity: 20~90%
Storage environment	Storage temperature: -10~60°C, storage humidity: 10~90%
Environmental conditions	
Drive	XP/Win7/Win10/Mac/IOS/Android
Print command	ESC/POS , TSPL command compatible
Character printing	It supports double width and double height printing of AN K characters, custom characters and Chinese characters; adjusts dot patterns of character spacing for printing;
printing of dot patterns	It supports printing of dot patterns with different densities and downloaded graphics

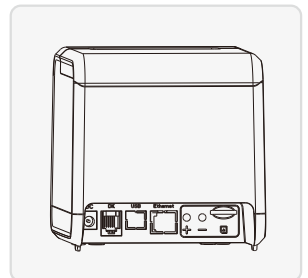
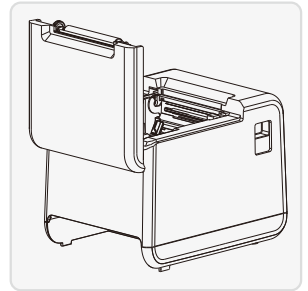
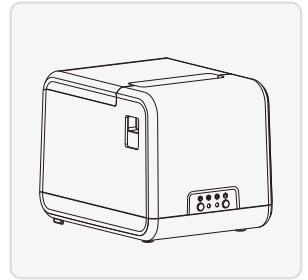





The pictures are for reference only, please subject to practicality

4.2 Printer Indicators

Type of printing paper Thermal paper rolls recommended	Thermal printing paper
Type of paper rolls	Specifications: AF50KS-E Manufacturer: Jujo Thermal Oy(Finland) Specifications: TF-50KS-E Manufacturer: Nippon Paper Industries Co., Ltd ⚠ Attention (1) To get the best results from the printer, choose the recommended paper or other paper with equivalent quality, otherwise the printing quality will be affected and even the service life of thermal print head will be reduced. (2) Please do not use the paper roll that the end glued on the core of the paper roll, otherwise it may cause damage to the printer. (3) If the printing paper is contaminated by chemicals or oils, it may fade or reduce the sensible heat degree, and affect the printing effect. (4) Do not rub the surface of the printing paper with hard articles, otherwise it may cause fading. (5) The print paper will fade if the temperature is up to 70°C,keep it out of direct sunlight, humidity and high temperature.

4.3 Printer Interfaces

Diagram	Type	Illustration
	USB	Universal USB Interface (Standard Type B)
	Network interface	Standard RJ45-8P interface, 10M/100M transmission speed with self-adaptation, 100M network LED indication, data communication LED indication.
	Cashbox Interface	The 6-wire RJ-11 socket, outputting DC 12V/1A power signal to drive the cashbox.
	Power interface	Power plug RP211:DC 8.5V $\overline{\text{---}}$ 3A / RP212:DC 12V $\overline{\text{---}}$ 2A

⊙ **Note:** The interface is optional or customized, and the specific interface is subject to the actual object.

V. Installation and Operation of Printer

5.1 Printer Unpacking

Check the parts:

Before use, make sure the accessories are included in the package(the following picture is an example). If any thing is missing, contact the supplier or manufacturer. The specific accessories may not be included depending on the printer model.

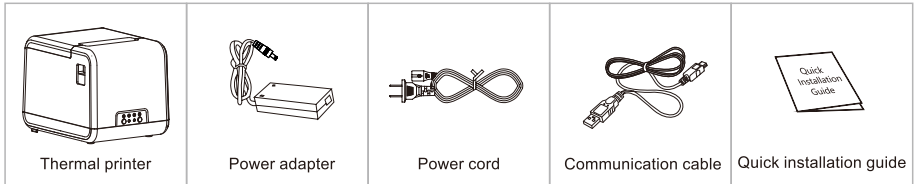

☺ The pictures are for reference only, please subject to practicality.

5.2 Connecting the Printer

- (1) Make sure that both the printer and the PC host are turned on, plug the matching data communication cable into the printer's data interface, and plug the other end into the USB of PC host.
- (2) If equipped with an electrically openable cashbox, insert the RJ-11 connector on the cashbox into the cashbox interface of the printer (the specifications of the cashbox must conform to the printer cashbox drive specifications).
- (3) Connect to the special power adapter of the printer.

Use the special power adapter for the printer.

The connection diagram is as follows:

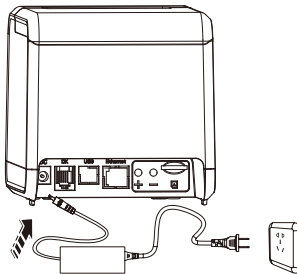

Attention:

- (1) First plug the power plug of the printer, then switch on the power supply, and then turn on the power switch. Do not reverse the sequence, otherwise the machine will be damaged.
- (2) Using an improper power adapter will make the printing quality worse and even damage the printer.
- (3) Do not connect the telephone line to the cashbox interface, otherwise the printer and telephone may be damaged.
- (4) When plugging in the printer power cord, please hold the arrow position of the printer power connector with your hand (do not plug in the cord of the printer power cord with your hand). Forcibly plucking the flexible cord of the printer power connector or pulling the printer power cord may cause damage to the printer or the power adapter.

5.3 Loading Paper

The thermal label printer uses thermal paper rolls and adopts an easy paper loading mechanism, which is very convenient for paper loading.

The Installation Method of Thermal Paper is as Follows:

- (1) Open the top cover of the printer and install the paper roll into the paper width adjuster (Figure 1);
- (2) Insert the roll paper as shown in the 2 illustration;
- (3) Pull out a part of paper, and close the cover as shown in the 3 illustration;
- (4) Tear off the paper with the cutter.

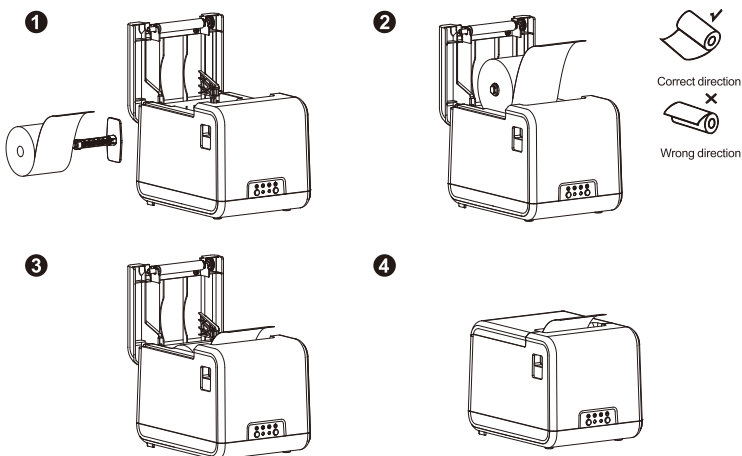

VI. The Switch, Key and Indicator Light of Printer

6.1 Keys and Indicators

The keys and indicator panel as shown in the following figure:

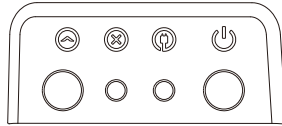

The function description of keys and indicators:

FEED key

Press the FEED button once to advance paper or hold down the FEED button to feed paper continuously. Hold down the FEED button and turn on the product at the same time to print the self-test.

POWER Indicator

The power button is used to turn on/off the printer. The printer's power button is located at the bottom right of the printer.

Press the power button to turn on the printer; and when the printer is on, press the power button to turn off the printer.

⚠ Attention: Make sure the power supply is connected before turning on the printer.

POWER indicator (green)

When connected to the power supply, it always lights up;

ERROR indicator (red)

The ERROR indicator will flashing when occur paper shortage, paper jam, printer head overheating, print head error or other abnormalities.

Buzzer error status and causes:

Status	Error causes
Two beeps	Printer mechanism installation error/ temperature below -50°C
Three beeps	Paper shortage
Five beeps	Temperature above 80°C
Six beeps	Cover is open
Ten beeps	Flash error

6.2 Self-Test of Printer

Self-test can detect whether the printer is working normally. If the Self-test list sample can be printed correctly, it indicates that everything is normal except the connection interface with the host computer, otherwise overhaul is required. In the self-test, it will print the software version number, print density, interface type, English characters and some Chinese characters in sequence.

The operation method of self-test is: after the printer is connected, press and hold the feed key first and then turn on the power supply of the printer. First, the printer will reset and detect, and release the feeding button less than 5 seconds after the reset is completed. At this moment, the printer will carry out self-test and print the self-inspection list sample.

6.3 Special Functions of Printer

6.4.1 WIFI function (alternative)

WiFi is a technology that allows electronic devices to connect to a WLAN. Currently, the company's printers use 2.4G RF frequency band. There is a password for protection for the connection to WLAN; However, it can also be public, thus allowing any device within WLAN range to be connected. For specific WIFI setting steps, please refer to the "WIFI" setting in the integrated tool setting manual.

6.4.2 Bluetooth function (alternative)

Bluetooth is a radio technology that supports short-distance communication of equipment (generally within 10m). It can conduct wireless information exchange among many devices including mobile phones, PDA, wireless headphones, notebook computers, related peripherals, etc. The Bluetooth standard is IEEE802.15, which works in the 2.4GHz band, and the bandwidth is 1 MB/s.

Bluetooth pairing and printing (only valid for printers with Bluetooth)

The Bluetooth printer needs to be paired with the main device driving the printer before working, and the pairing process is initiated by the main device.

The general pairing method is as follows:

- (1) Turn on the printer.
- (2) The main device searches for external Bluetooth device.

- (3) If there are multiple external Bluetooth device, select the printer corresponding to MAC address (see self-test page for details).
- (4) Enter the initial password "0000" or "1234".
- (5) Complete the pairing.

Please refer to the Bluetooth function description of the main device for the specific pairing method. When pairing, the RP335 thermal label printer with Bluetooth interface must be on.

⚠ Note: During pairing, please do not turn on multiple printers at the same time, otherwise you may not be able to judge which printer was successfully paired.

After successful pairing, other host computers can still be paired with the printer, and each printer can be paired with up to 8 host computers. If more upper computers are paired with printers, the host computer paired with the printer at the earliest will be automatically removed from the pairing list by the printer. At this time, if this host computer needs to drive the printer for printing, it needs to be paired again.
(For multi-connected Bluetooth only)

**Use Bluetooth interface for printing
(only valid for the printers with Bluetooth)**

For host computers with virtual Bluetooth serial ports (such as mobile phones using SMARTPHONE, POCKET PC, PALM, notebook computer, etc.), after successful pairing, printing data can be sent to the printer via the virtual Bluetooth serial port for printing. If the host computer does not have a virtual Bluetooth serial port, when you want to drive the printer for printing, please consult the supplier of the host computer.

VII. USB Interface

The USB interface socket of thermal label printer is standard B type.

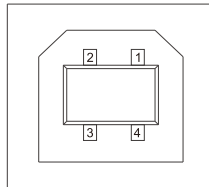

PIN	SIGNAL NAME
1	VBUS
2	D-
3	D+
4	GND

VIII. Ethernet Interfaces of Printers

The Ethernet interface socket of thermal label printer is standard RJ45-8P, it supports 10M/100M network, and the transmission speed is adaptive.

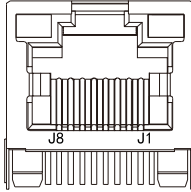

Pin number	Description	Illustration
1	TX+	Send differential line+
2	TX-	Send differential line-
3	RX+	Receive differential line+
4	NC	No function
5	NC	No function
6	RX-	Receive differential line-
7	NC	No function
8	NC	No function

IX. Cashbox Interfaces of Printers

The cashbox interface of the printer adopts RJ-11 standard, 6-wire socket, and outputs DC 12V/1A power signal to drive the cashbox. Insert the RJ-11 crystal connector of the cashbox into the cashbox interface to open the cashbox through the printer.

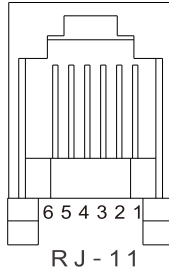

The functions of each pin of the cashbox interface of the printer are defined as follows:

Pin number	Signal	Description
1	GND	Power supply ground
2	Dk1	Negative pole of cashbox 1#
3	DK-1N	Start detection
4	PWR	Positive pole of power supply/cashbox
5	Dk2	Negative pole of cashbox 2#
6	GND	Power supply ground

☺ Select the interface definition above to purchase the cashbox

X. Cleaning the Printer

10.1 Cleaning the Printer Head

Clean the print head when one of the following conditions occurs to the printer:

- (1) Printing is not clear;
- (2) A vertical column of the printed page is not clear;
- (3) The paper feeding noise is high.

The print head cleaning steps are as follows:

- (1) Disconnect the power cord, open the upper cover and remove the paper if exists.
- (2) If printing has just been completed, wait for the print head to cool completely;
- (3) Clean the printer head with a soft cotton moistened with ethyl alcohol.
- (4) After waiting for absolute ethyl alcohol to volatilize completely, close the upper cover and try printing again.

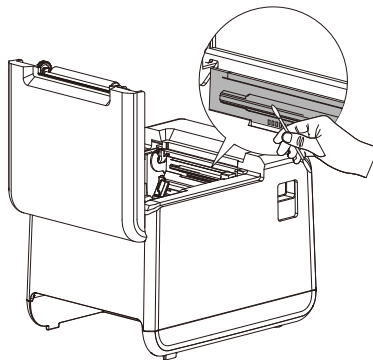

10.2 Cleaning the Sensor

Clean the paper shortage sensor when one of the following conditions occurs to the printer:

- (1) In the printing process, the printer occasionally stops printing and alarms for paper shortage;
- (2) It does not give alarms for paper shortage.

The paper shortage sensor cleaning steps are as follows:

- (1) Turn off the power supply of the printer, open the upper cover, and remove the paper if there is any;
- (2) Wipe off the dust and stain on the sensor surface with soft cotton cloth (which should be dried) dipped in absolute ethyl alcohol.
- (3) After waiting for absolute ethyl alcohol to volatilize completely, close the upper cover and try to start the machine again.

10.3 Cleaning the Printing Rubber Roller

When one of the following conditions occurs to the printer, the printing rubber roller should be cleaned:

- (1) Printing is not clear;
- (2) A vertical column of the printed page is not clear;
- (3) The paper feeding noise is high.

The printing Rubber Rollers cleaning steps are as follows:

- (1) Turn off the power of the printer and open the upper cover;
- (2) Use a soft cotton cloth (which should be dried) dipped in a neutral detergent to wipe off dust and stains on the surface of the printing rubber roller;
- (3) Close the upper cover after the cleaning agent is completely volatilized.

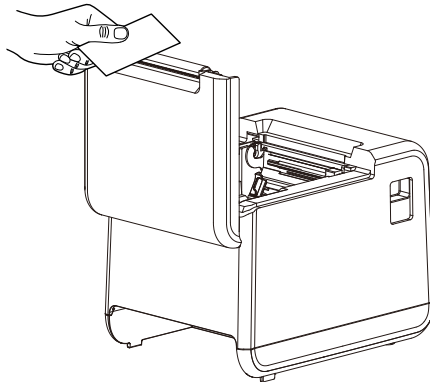

⚠ Attention:

- (1) The power supply must be turned off during the daily maintenance of the printer.
- (2) Do not touch the surface of the print head with hands and metal objects, and do not scratch the surface of the print head, printing rubber roller and sensor with tweezers and other tools.
- (3) The organic solvents such as gasoline and acetone shall not be used.
- (4) Wait until absolute ethyl alcohol is completely volatilized, then turn on the power supply to continue printing.

XI. Troubleshooting

When the printer fails, it can be handled according to the method in this section. If the problem cannot be solved, please contact the distributor or manufacturer.

11.1 The indicator on the control panel is not on

Check whether the power cord is properly plugged into the printer, power adapter, and power outlet or not. Check if the printer's power switch is on.

11.2 The indicator is normal, while the printer does not work

Run the self-test to check whether the printer can work properly. If you cannot perform self-test, please contact your distributor or the technical service personnel.

If the self-test can be performed normally, check the following:

- (1) Check the interfaces at both ends of the connection line between the printer and the computer. At the same time, confirm whether the connection meets the specifications of printer and computer.
- (2) The data transfer settings between the printer and the computer may be different. You can use self-test to print out the printer's interface settings. If the printer cannot print, please contact your distributor or the technical service personnel.

XII. Driver Installation

There are two ways to drive the thermal label printer, one is to install the driver directly under XP, Win7, Win8, Win10, Linux, MacOS, the other is to use the port for direct driving.

12.1 Installation for Windows

Add the printer to Windows and assign the driver files in the driver disk to Windows. You can start printing only by calling the print command in the program. In this way, the printer driver of Windows actually converts characters into graphic dot matrix for printing.

12.2 The Port direct drive

In this way, there is no need to use a driver, only the characters need to be directly output to the port, and the built-in and cartridge font inside the printer is used to realize the conversion and printing of the characters. Using the port direct drive way, the printing mode is also changed from page printing mode to line printing mode, making printing control more convenient. If the port direct drive mode is used, the instruction set needs shall be used to control the printing of the printer, specifically supported For the print command set, please refer to the [Printing Parameters] option in the [Print command] on page 5 of this manual.

☺ Driver installation details see < Thermal label printer-Driver installation instructions >



Rongta Technology (Xiamen) Group Co., Ltd.

ADD: No.88, Tonghui South Road, Tongan, Xiamen, China.

WEB: www.rongtatech.com

TEL: 0086-592-5666129 FAX: 0086-592-5659169

